

Y13013 / Y13014- Mobile Stack Chair Assembly Instructions (With Optional Chromed Arm)

Parts Listing

A



4 pcs for Seat

B



2 pcs for Back

C

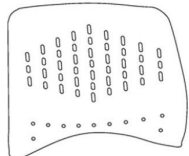

Backrest - 1 pc

D



Seat - 1 pc

E

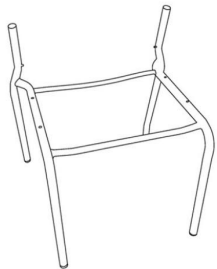

Steel Frame - 1 pc

F



Caster - 4 pcs

G

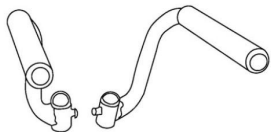

AF-02 Chromed Arm
- 1 pair (Optional)

H



Chromed Screw
- 2 pcs (Optional)

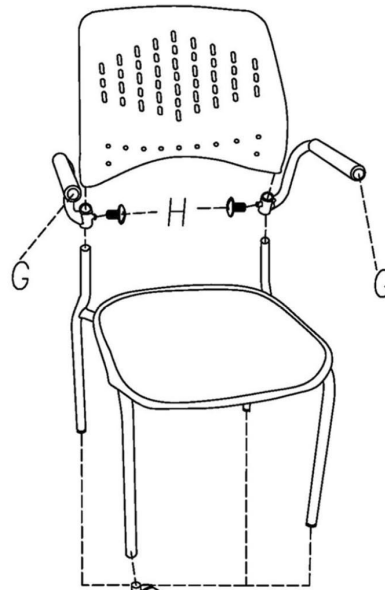

Step 1

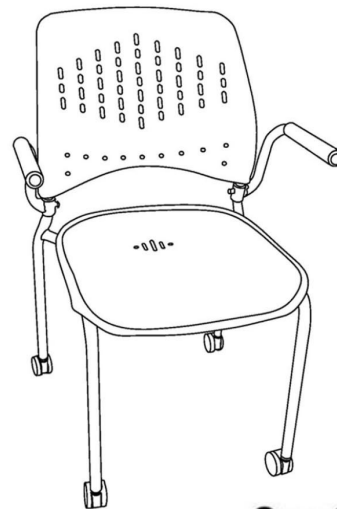

Tools needed : Phillips Screwdriver

Step 1 : Snap four (F) Casters into (E) Steel Frame by hand.

Step 2 : Attach (D) Seat to (E) Steel Frame by using four (A) screws and screwdriver. DO NOT FULLY TIGHTEN SCREWS ! LEAVE THEM SOMEWHAT LOOSE FOR THE NEXT STEP.

Step 3 : Attach (G) Chromed Arm on the rear tube of (E) Steel Frame and MUST HAVE ARM TOUCH THE STOP PIN ON BOTH SIDE OF THE REAR TUBE and use two (H) Chromed Screws into the hole, which is right on top of the stop pin. Then place (C) Backrest on top of (E) Steel Frame. Line up the two holes on the back of the (C) Backrest and connect using the two (B) Screws. In the end, fully tighten all screws.

Step 2

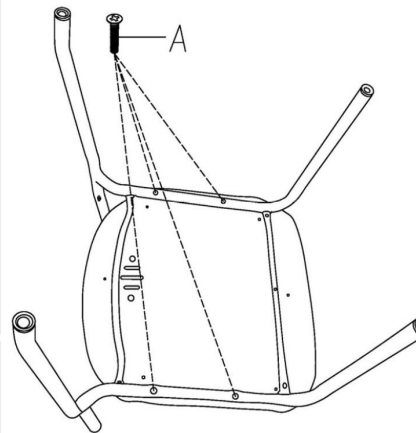

Step 3

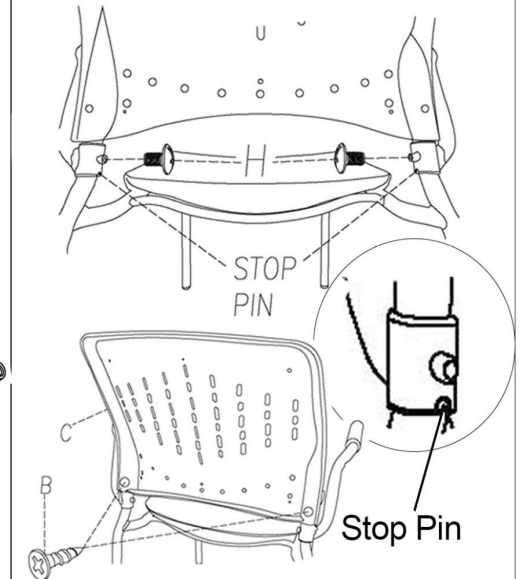

Questions? Call Customer Service at 1-800-443-5117
Monday - Friday 8:30 AM to 5:00 PM Central Time