

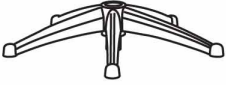











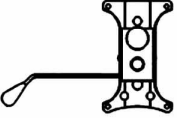

Y11854

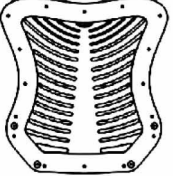
Mesh Office Chair Assembly Instructions

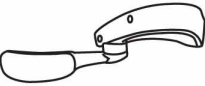
PARTS

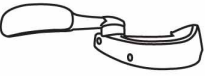
<p>① X 1</p> 	<p>A.M6*25X4</p> 
<p>② X 1</p> 	<p>B.M6*20X4</p> 
<p>③ X 1</p> 	<p>C.M6*35X4</p> 
<p>④ X 1</p> 	<p>D.X4</p> 
<p>⑤ X 1</p> 	<p>E.X1</p> 
<p>⑥ X 1</p> 	<p>F.X5</p> 
<p>⑦ X 1</p> 	<p>G.X4</p> 

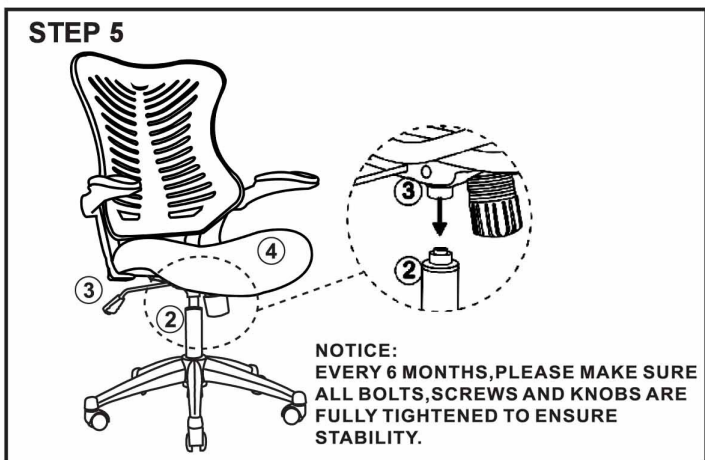
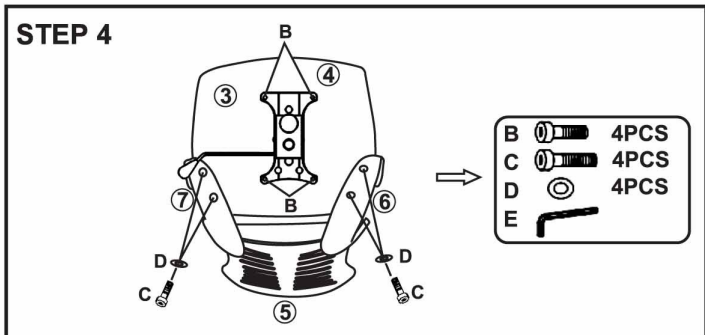
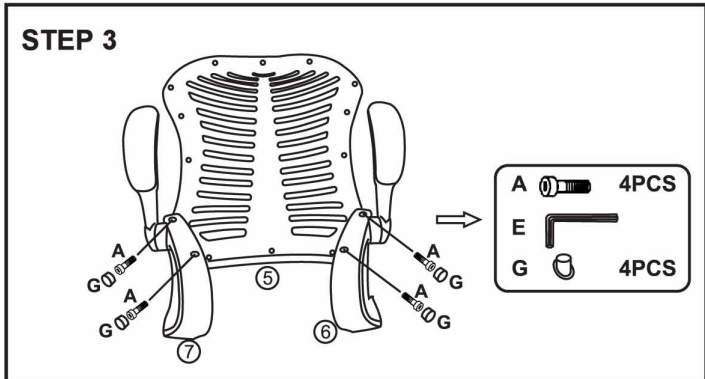
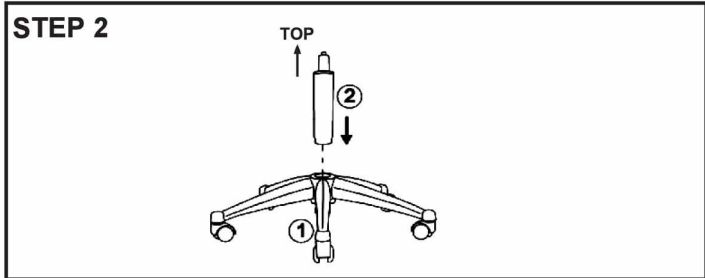
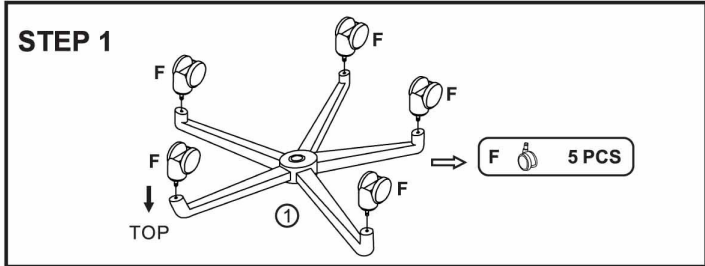

BT-6336 / Stool Kit

Assembly Diagram

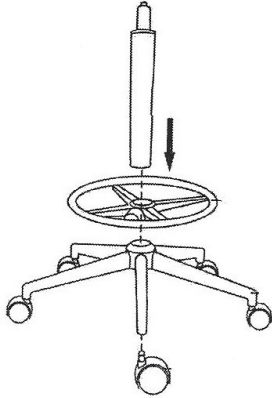

****Warning****

Reclining while seated at an elevated height can be a tip hazard. For safety, it is recommended that the forward tilt lock be engaged while at taller seated heights.